

Smart SV-07B Selector Valve Quick Use Guide

Please read the following notes carefully and follow it strictly for correct and safe use of product.

1. Item list

Name	Quantity
Smart SV-07B Selector Valve	1 set
Nine-color line accessory kit	1 pc
Operation and User Manual QR code	1 sheet
Certificate of Conformity	1 sheet

2. Cable Connection and Debugging

2.1 Power Cable and Communication Cable

Item	Color
RS232 communication cable	Blue and white-RX, Black and White-GND Orange and White-RX
RS485, CAN communication cable	Orange-B, Purple-A, Green-H, Yellow-L
Power cable	Red-positive polar, black-negative polar

Please refer to the following figure for cable connection

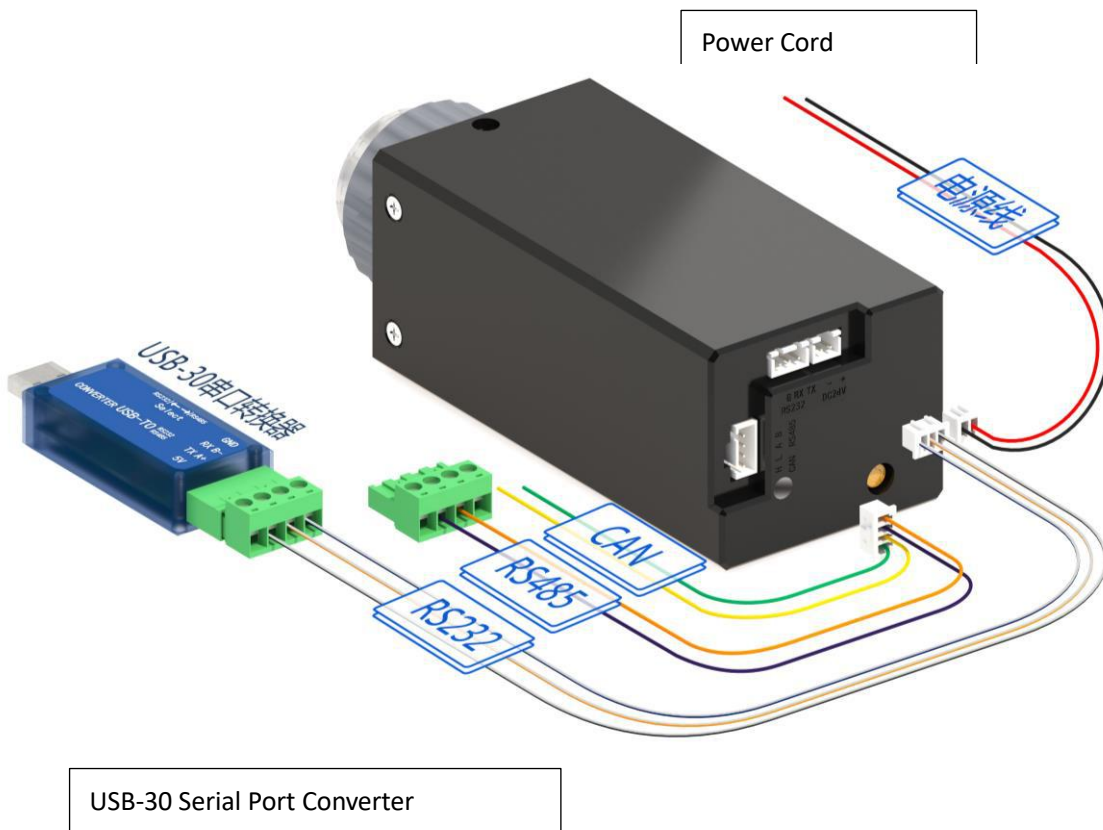

2.2 USB Driver and Debugging Software Installation

If you are using our USB To RS232/RS485 debugger for the first time, please download the debugger driver from the official website

1. Login to the official website (<http://www.runzeliuti.com>), Click on the hyperlink to go directly to the download page;
2. "Download"->"Debug Tools"->"USB to RS232, RS485 converter driver "Click to download
3. Driver installation

Open the application file  SETUP.EXE confirm it is the CH341SER.INF file, click Install, and then click OK, the installation is complete.

4. Download Debugging Software

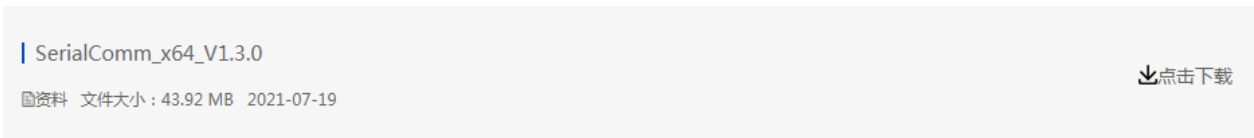

3. Quick Use

3.1 Debugging Software

Open the debugging software serialcomm, Figure 3-1-1 baud rate is the baud rate of the slave computer, the factory default is 9600bps, after setting the serial port and baud rate, click the "Port" button, then click on the Command Generator icon  in the top left or click on the Tools button to open the Command Generator

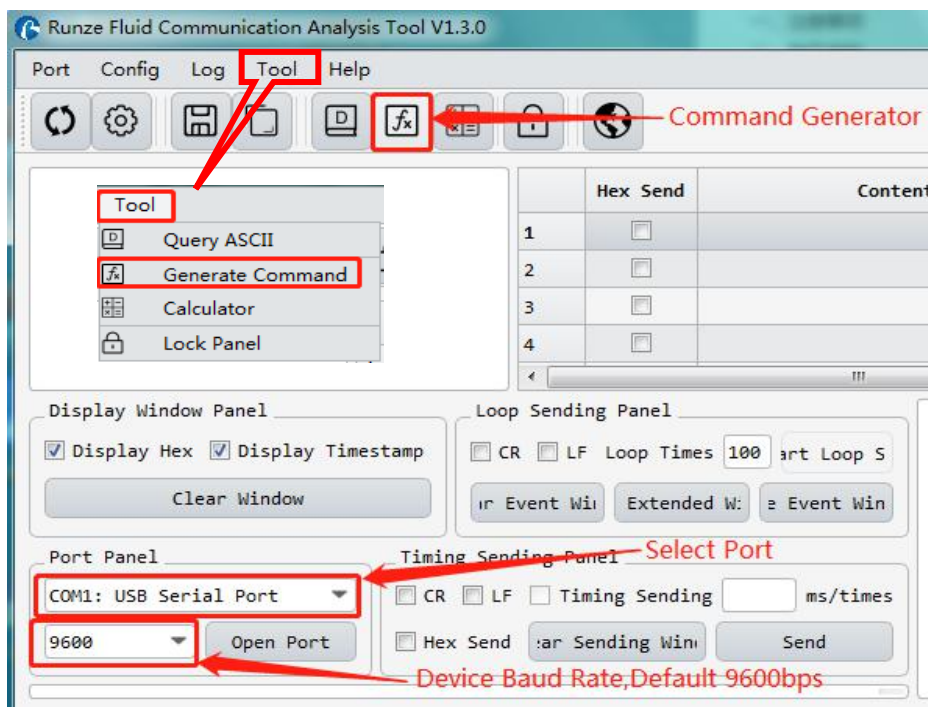

Figure 3-1-1

In the command generation tool, input the address, command, parameters, the command corresponds to various command codes of B2, parameters correspond to B3, B4, if it is a factory command, you need to check the factory mode, if it is a general command is not necessary to check. After setting, click Generate and Copy, the command display box on the right can show the current generated code and has been copied in the clipboard, as shown in Figure 3-1-2 below.

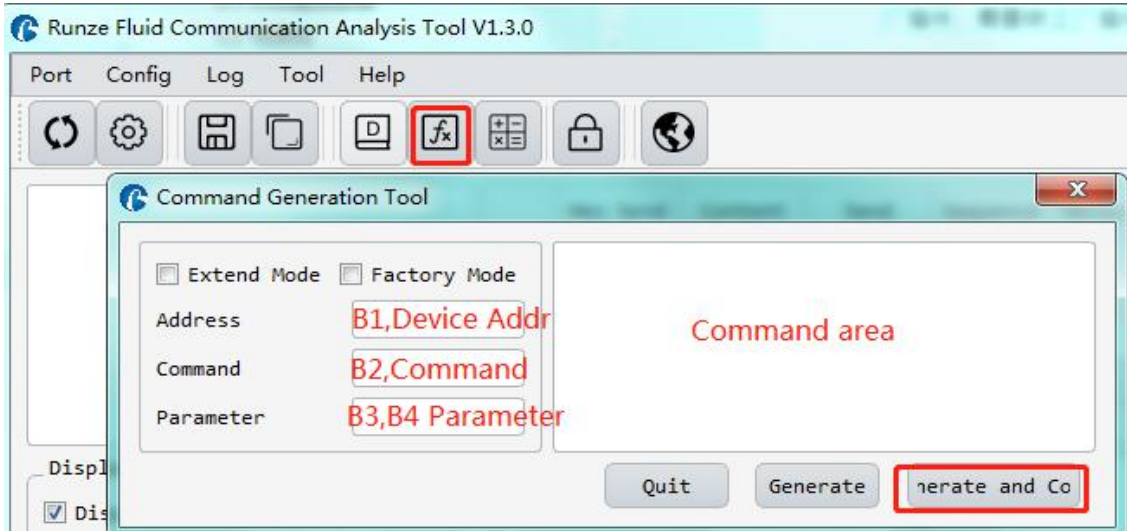

Figure 3-1-2

Note: The input of address, command and parameter boxes are all in hexadecimal.

Return to the main interface of debugging software, double-click the input box under "content", right-click to paste the copied command or use the shortcut key ctrl+V to paste the copied command. Then check the "hex send" ahead and click the blank button in the corresponding line under "send" to send the command.

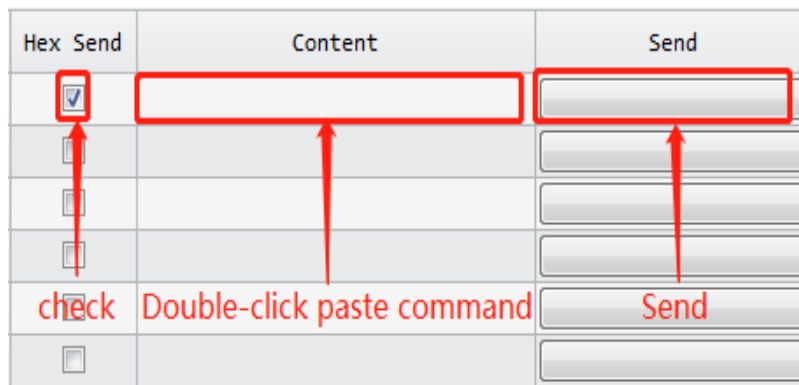

Figure 3-1-3

3.2 Examples of Communication

- ① Send Command: 0x20 query the device address

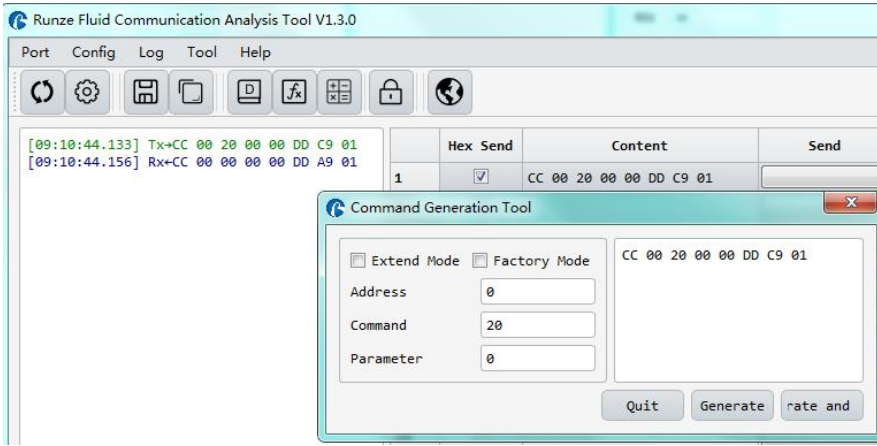

Figure 3-2-1

- ② Send command: 0x44 switching port command

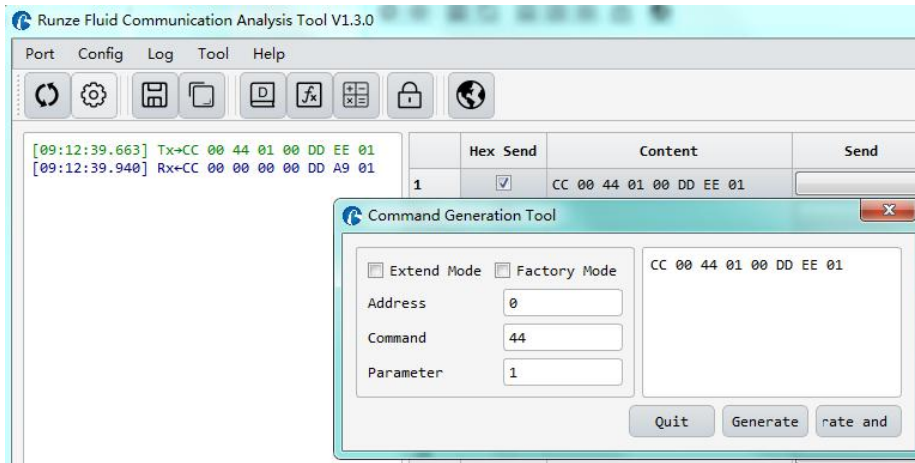

Figure 3-2-2

Paste the copied command in the blank space below "Send", check the 'hex send' in front, then click send, get the return code and B2 byte is 00, then it means port switching is successful.

Note: To switch between RS232 and RS485 communication modes, please turn the dial code on the USB-30 to the corresponding position.

4. Quick Commands

Code B2	Abbreviation	Parameter B3 B4
0x20	Query address	The address ranges from 0x0000 to 0x007F. The default value is 00
0x3E	Query current channel position	B3=0x00 B4=0x00
0x3F	Query current version	B3=0x01 B4=0x09, above is an example, if the response parameter is the same as above parameter, it means the current version is V1.9, see the version number on the label for details
0x4A	Query motor state	B3=0x00 B4=0x00
0x44	The motor rotates through the code disc, and selects the best path automatically	It depends on the actual number of valve channels. For example, for the selector valve with 10 channels, B3=0xXX B4=0x00, where the value range of XX is 01 ~ 0A.
0x45	Reset	B3=0x00 B4=0x00 The selector valve runs to the reset optocoupler and stops.
0x4F	Origin reset	B3=0x00 B4=0x00 The selector valve runs to the encoder origin position, which overlaps with reset position of the 0x45 command.
0xA4	Switch the port according to the required direction	According to the actual number of ports of the selector valve, the parameter cannot exceed the maximum number of ports of the current valve, and B3, B4 must be two adjacent ones.
0xB4	Switch between ports according the required direction	According to the actual number of ports of the selector valve, the parameter cannot exceed the maximum number of ports of the current valve, and B3, B4 must be two adjacent ones.
0x49	Strong Stop	B3=0x00 B4=0x00

5. Common Problems & Solutions

Phenomenon	Problem	Solution
Not working when power on	The working voltage is not in the acceptable range.	Test whether the voltage is within the specified range
	The connection is loose or disconnected.	Check whether the connection is good.
	The working current is not in the acceptable range.	Detect whether the current is within the specified range
Sending a command without a return code	Chose the wrong serial port	Please check the corresponding serial port via Device Manager
	The TX and RX lines of RS232 are connected reversely or phase A & B of RS485 are connected reversely.	Exchange the TX and RX line sequence of RS232 and exchange the phase A & B sequence of RS485.

The sent and received communications are consistent in RS232.	TX and RX are in short circuit.	Check whether there is short circuit, if so, replace the cable.
Working but the sent and received communications are consistent in RS485,	A B reversed, and the USB converter is not dialed to RS485	Switch AB and dial USB to RS485 communication

6. Installation and Use

- ◆ Applicable power supply: 24V±10%, 1A, When using a linear power supply, the voltage and current must be adjusted to the corresponding parameter values
- ◆ Please use RUNZE debugging software serialcomm for product debugging
- ◆ While debugging, try to debug over liquid to avoid dry wear of the spool, which will affect the service life of the valve
- ◆ While using this product, please connect to GND to reduce the interference brought by environmental factors
- ◆ When not using this product, remember to clean the valve ports with cleaning solution such as alcohol or water to avoid long periods of test residue in the valve passage, resulting in port blockage.
- ◆ When installing this product, please install it on the existing installation holes, additional holes are strictly prohibited. For special requirements, please consult sales or technical support.